

CAROLINE BOUVIER

h o m m e

# Sommaire

---

La coupe de la veste

Page 1

Le style de la veste

Pages 2 - 4

La veste déstructurée

Pages 5 - 6

La veste de cérémonie

Pages 7 - 9

Le style de poche de veste

Pages 10 - 12

Le style de poche poitrine

Page 13

La surpiqure AMF

Page 14

Les options secondaires

Pages 15 - 16

La tête de manche

Page 17

Le bas de manche

Page 18

Les doublures intérieures

Page 19

La coupe du pantalon

Page 20

Le style de poche pantalon

Pages 21 - 22

Le devant du pantalon

Page 23

La ceinture

Pages 24 - 25

Les fermetures du pantalon

Page 26

Le pantalon Sartorial

Page 27

La surpiqure AMF

Page 28

La finition du bas

Page 29

Le gilet de tailleur

Page 30

Les options du smoking

Page 31

Le costume pour enfant

Pages 32 - 33

# La coupe de la veste

## Slim, regular, comfort

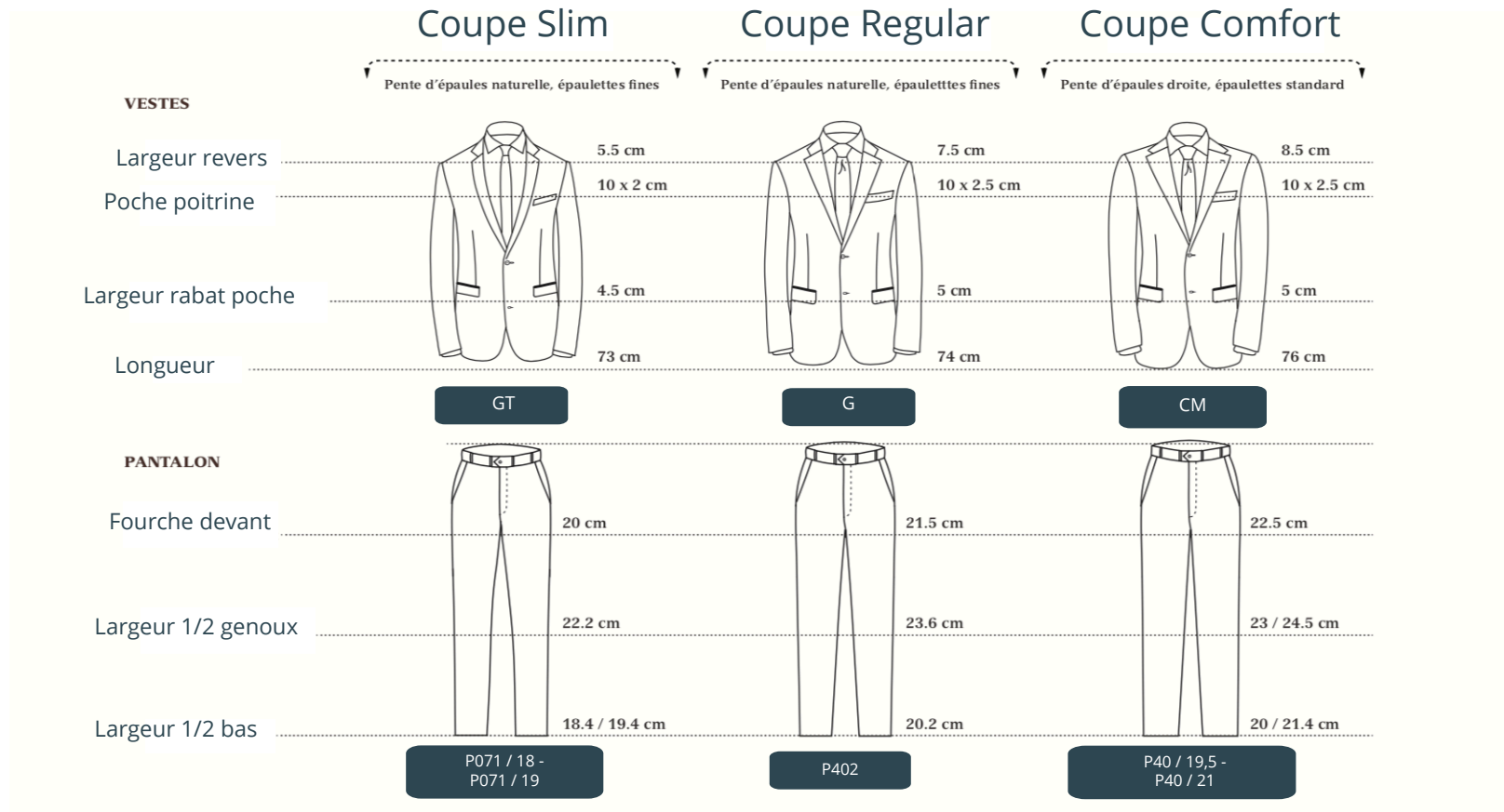

# Le style de la veste

## GT (slim) | G (regular) | CM (confort)

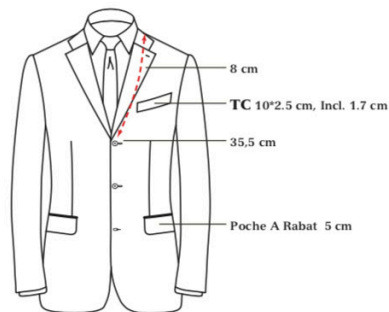

**06**  
Revers droit - 3 boutons

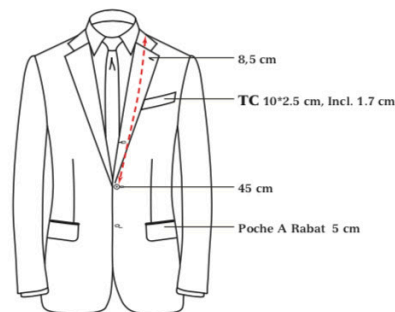

**406**  
Revers droit - 2/3 boutons

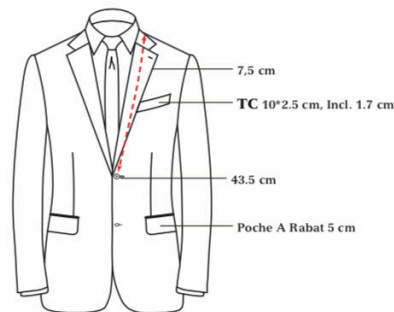

**16**  
Revers droit - 2 boutons

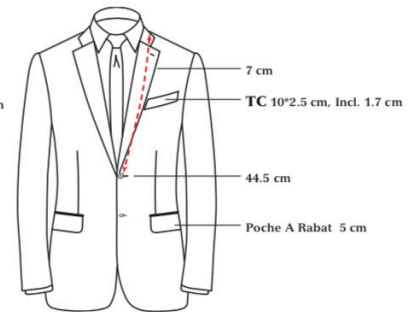

**96**  
Revers droit - 2 boutons

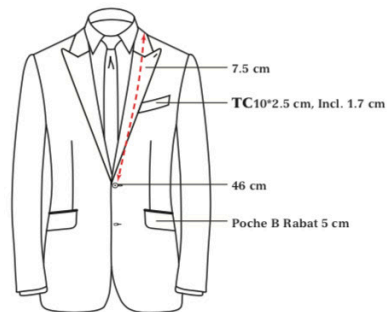

**32**  
Revers en pointe  
2 boutons

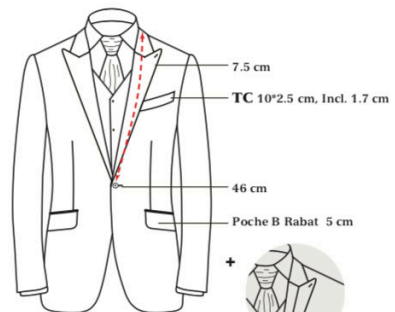

**42**  
Revers en pointe  
1 bouton

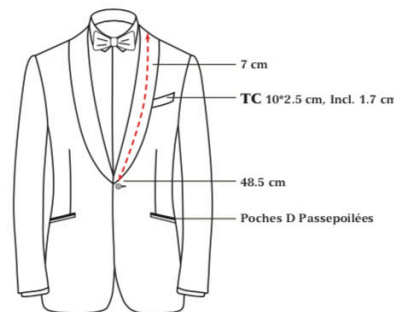
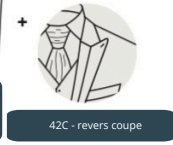

**591**  
Revers châle - 1 bouton

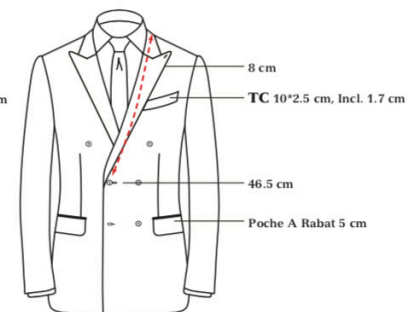

**DB54**  
Revers en pointe  
veste croisée

# Le style de la veste

## GT (slim) | G (regular)

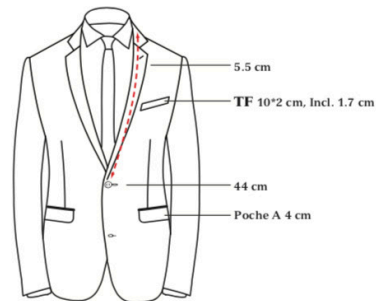

82  
Revers droit - 2 boutons

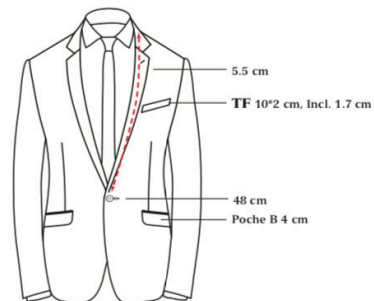

83  
Revers droit - 1 bouton

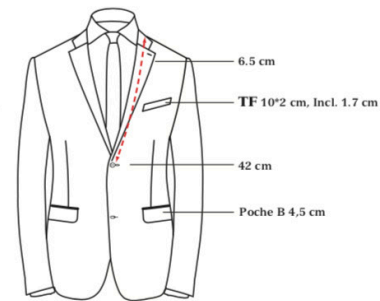

73  
Revers droit - 2 boutons

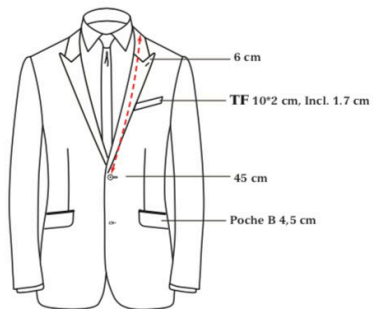

58  
Revers en pointe  
2 boutons

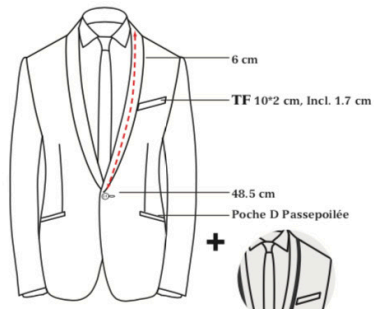

59  
Col châle - 1 bouton



59C  
Revers châle avec découpe  
de 1cm sur le bord du col

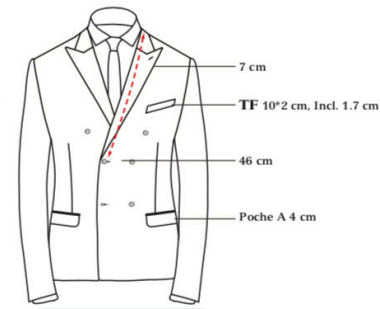

84\*\*  
Revers en pointe  
veste croisée

Longueur conseillée pour une  
taille 50 : 70cm

# Le style de la veste

GT (slim) | G (regular)

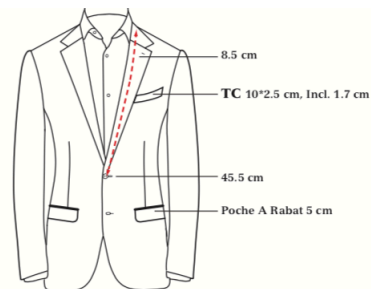

402  
Revers droit - 2 boutons

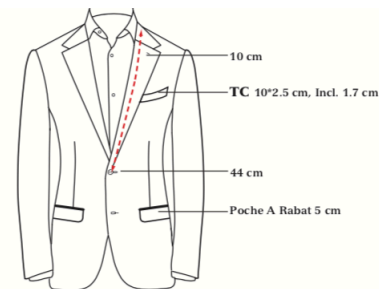

409  
Revers droit - 2 boutons

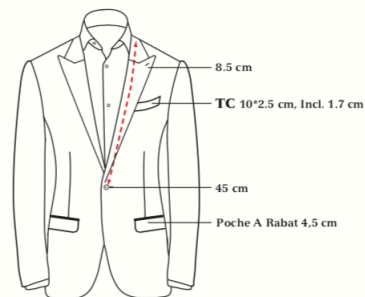

426  
Revers en pointe  
1 bouton

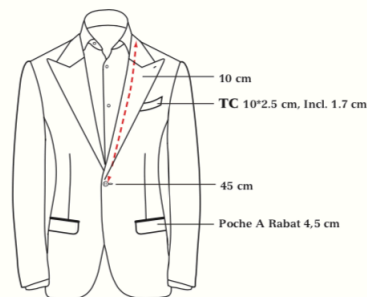

428  
Revers en pointe  
1 bouton

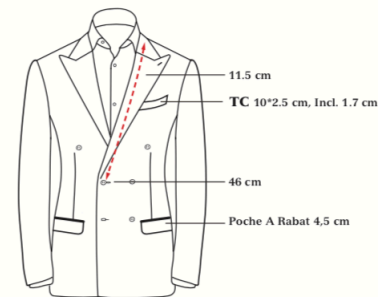

542R  
Revers en pointe  
veste croisée

# La veste destructurée

GTN (slim) base GT - manches NA

GN (regular) : base G - manches NA

penne d'épaules naturelle  
cigarette très fine

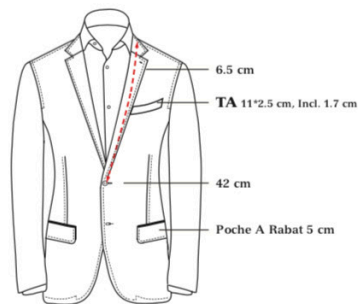

73  
Revers droit - 2 boutons

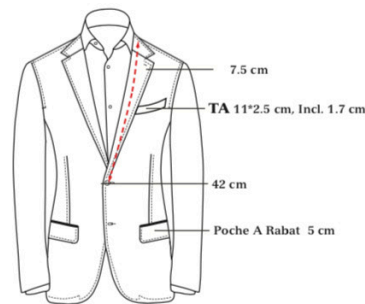

16  
Revers droit - 2 boutons

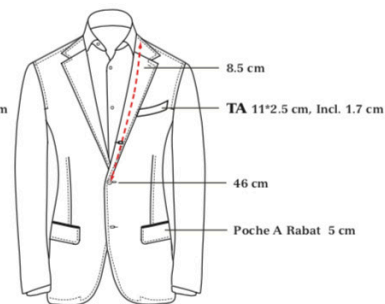

406  
Revers droit - 2/3 boutons

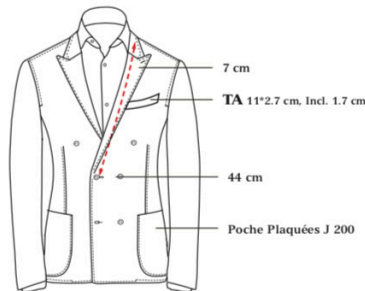

647  
Revers en pointe  
2 boutons

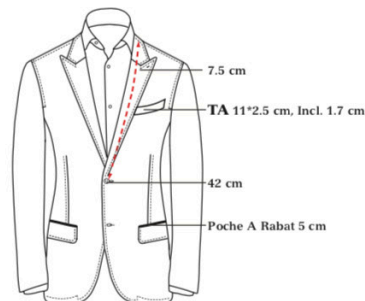

32  
Revers en pointe  
2 boutons

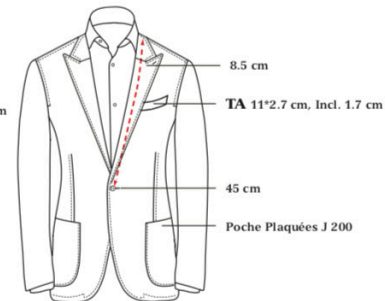

426  
Revers en pointe  
1 bouton

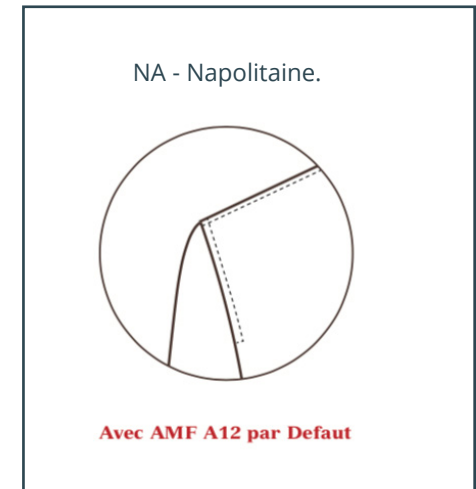

Ces vestes destructurées sont disponibles uniquement avec intérieur AF ou AF1

# La veste déstructurée

**GTN** (slim) base **GT** - manches **NA**  
**GN** (regular) : base **G** - manches **NA**

penne d'épaules naturelle  
 cigarette très fine

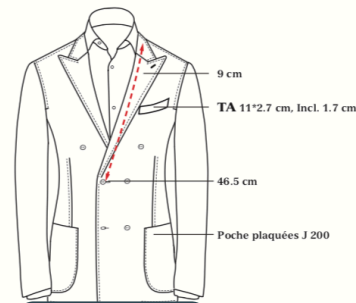

**DB**  
 Revers en pointe  
 veste croisée

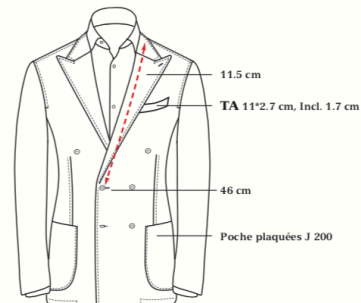

**542**  
 Revers droit  
 veste croisée

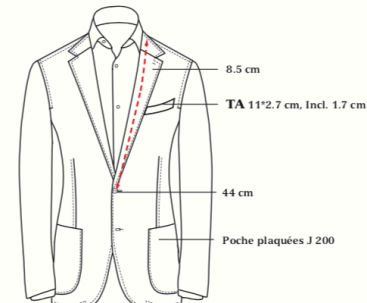

**402**  
 Revers droit  
 2 boutons

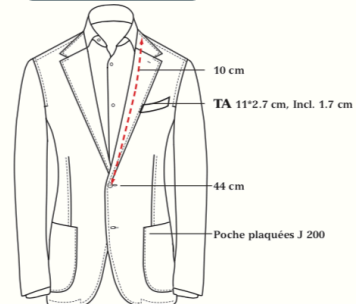

**409**  
 Revers droit  
 2 boutons

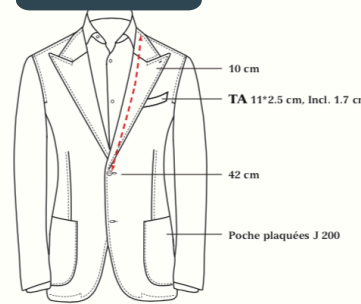

**328**  
 Revers en point  
 2 boutons

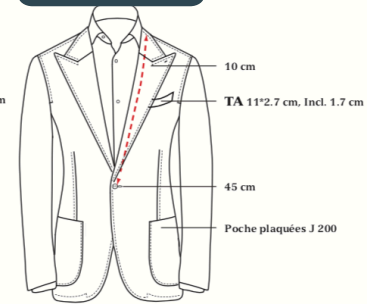

**428**  
 Revers en point  
 1 bouton

Ces vestes déstructurées sont disponibles uniquement avec intérieur AF ou AF1



# La veste de cérémonie

GT (slim) | G (regular)

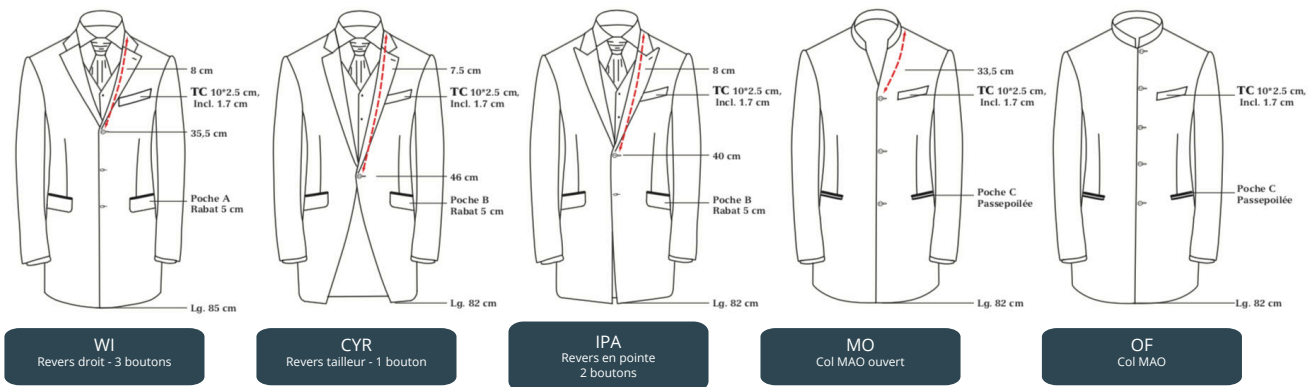

# La veste de cérémonie

GT (slim) | G (regular)

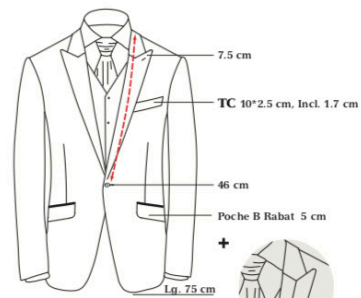

**42**  
Revers en pointe  
1 bouton

**42C**  
Revers coupe

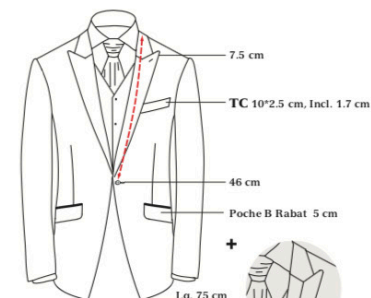

**42R**  
Revers en pointe  
1 bouton

**42RC**  
Revers coupe

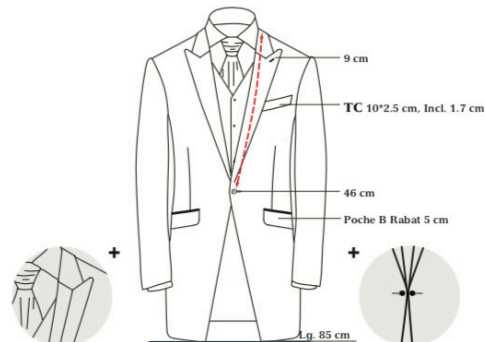

**FRC**  
Revers coupe

**FR**  
Revers en pointe  
1 bouton

**FDB**  
Fermeture par passementerie

Code à inscrire dans la case "options secondaires"

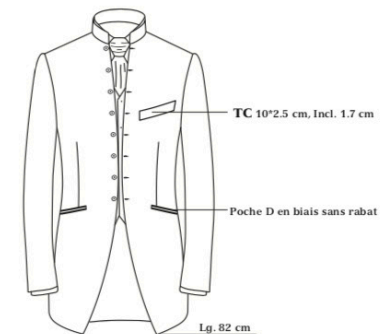

**FO**  
Col MAO - 8 boutons

# La veste de cérémonie

GT (slim) | G (regular)

longueur conseillée pour une taille  
50 : 105 cm

## Evening tail

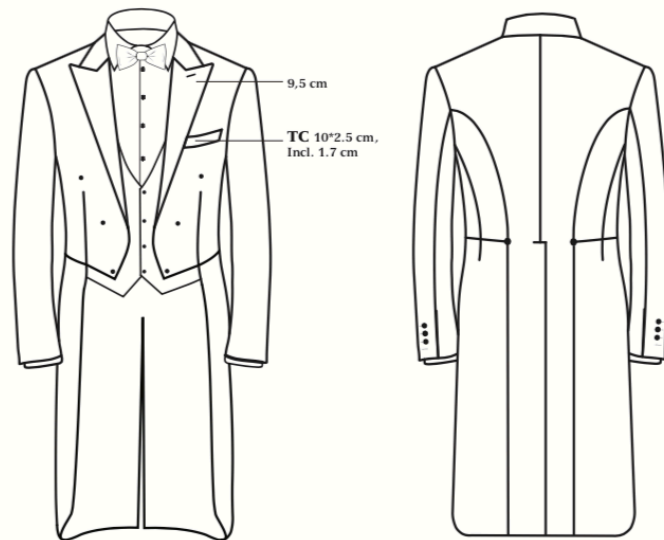

TAIL

## Morning coats

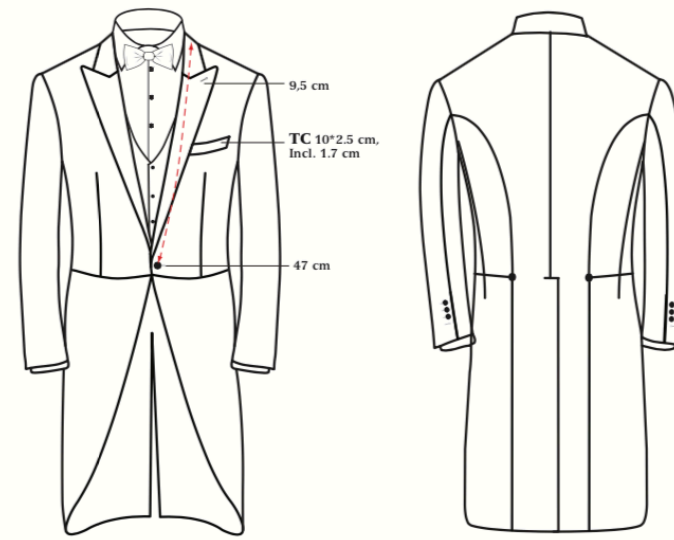

CUT

# Le style de poche - veste



Hauteur rabats :

POUR REVERS FIN  $\leq$  6CM

R40

Rabats 4 cm  
Poche poitrine 10\*2 cm

R45

Rabats 4,5 cm  
Poche Poitrine 10\*2 cm

POUR REVERS STANDARD  $\geq$  7 CM

R50

Rabats 5 cm  
Poche poitrine 10\*2,5 cm

# Le style de poche - veste



PZ  
sans poche



PQ  
droites à rabats boutonnés



PO  
plaquées à rabats

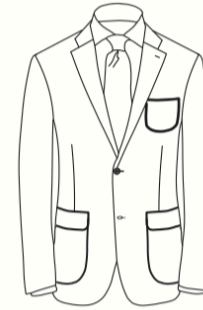

PP  
plaquées à rabats avec  
poches poitrine plaquées

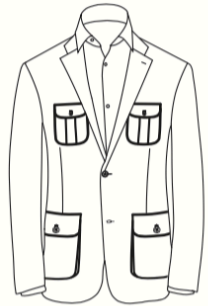

RU1  
4 poches plaquées à rabats

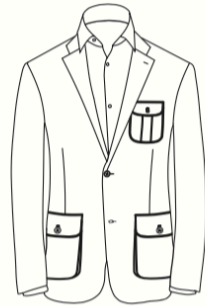

RU11  
3 poches plaquées à rabat

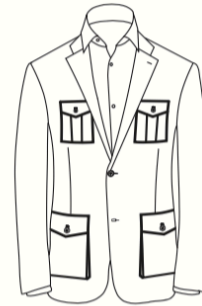

RU2  
4 poches plaquées à rabats



RU22  
2 poches plaquées à rabats

# Le style de poche - veste

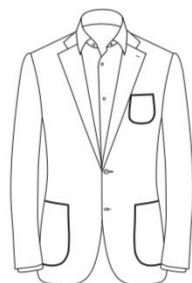

L100  
3 poches plaquées à rabats

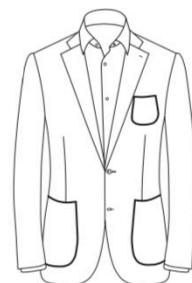

L200  
3 poches plaquées à rabats

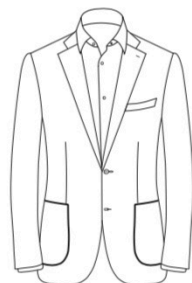

J100  
2 poches plaquées à rabats

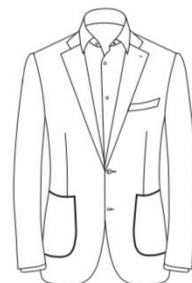

J200  
2 poches plaquées à rabats

# Le style de poche - poitrine

TC :  
Poche poitrine classique

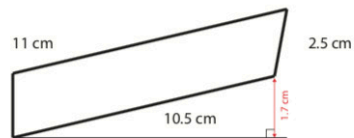

Sélectionné par défaut\*

Pour revers standard  $\geq 7$  cm et/ou poches rabat 5 cm

TF :  
Poche poitrine fine

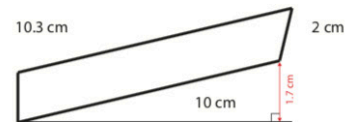

Sélectionné par défaut\*

Pour revers fin ( $\leq 6$  cm) et/ou poches rabats fin (de 4 à 4,5 cm)

TF :  
Poche poitrine arrondie

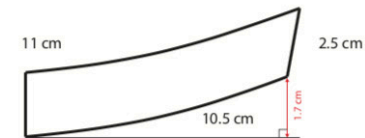

Sélectionné par défaut\*

Pour construction Semi-traditionnelle ou Traditionnelle

# La surpiqure AMF et la bouttonnière

The diagram illustrates different construction options for a jacket, categorized by AMF (Applique Manches Fines) and button types (Bouttonnière).

**AMF Options:**

- 0 - sans -**: No AMF.
- A1 AMF 1mm**: AMF 1mm, A1 + pince devant + fente manche + fente dos + demi-lunes.
- A5 AMF 5mm**: AMF 5mm, A5 + pince devant + fente manche + fente dos + demi-lunes.
- A11**: AMF 1mm, A1 + pince devant + fente manche + fente dos + demi-lunes.
- A12\***: AMF 1mm, A1 + pince devant + fente manche + fente dos + demi-lunes + épaules.
- A51**: AMF 5mm, A5 + pince devant + fente manche + fente dos + demi-lunes.
- A1F\***: AMF 1mm, A1 + pince devant + fente manche + fente dos + demi-lunes + épaules + couture coté + fente.
- A5F\***: AMF 5mm, A5 + pince devant + fente manche + fente dos + demi-lunes + épaules + couture coté + fente.

**Buttons (Bouttonnière) Options:**

- S2 2 mm - tone/tone**
- S5 5 mm - tone/tone**
- S2X 2 mm - contrast**
- S5X 5mm - contrast**

**Bouttonnière revers (Reverse Button Options):**

- BRI - Classique ouvert**
- BRO - Cèillet fermée**
- BRC - œillet ouvert**
- BRN - Classique fermée**
- BRR - Cèillet partiellement ouvert**
- BRM - Milanaise cousue main**

**Code à inscrire dans la case "options secondaires"**  
**Disponible uniquement pour construction Traditionnelle**

\* Disponibles uniquement pour BASE GTN - GN



# Les options secondaires



IFR  
Support boutonnère Fleur



SGF  
Patte serrage col amovible

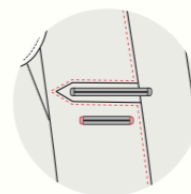

Columbia + DTACK  
Contrast  
Supiqure + Demi-lune contrastes

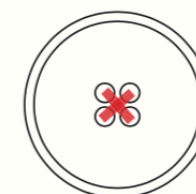

BXC  
Boutons cousus avec fil  
contraste



CX  
Col contrasté



USX  
UXS - 'banane' en tissu contrasté

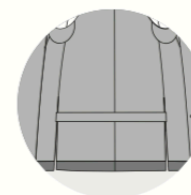

FB  
'Passant' fentes  
Disponibles seulement avec intérieur  
Contrastée, Multico et HLB!



FP  
Faux pochette

\* Choix suivant Catalogue Accessoires, "Fils Contrastés"

# Les options secondaires

## Le monogramme

### Position de monogramme



CFM  
Feutre de col



CIM  
Au dessus de poche gauche

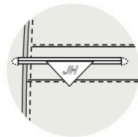

CTM  
sur pattes de fermeture poche

### Type de monogramme



MB  
Baton



MA  
Anglaise

\*\* Option par défaut

# La tête de manche

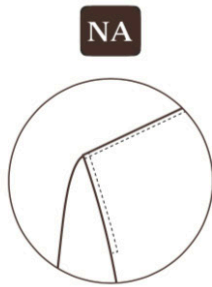

Napolitaine

**Avec AMF A12 par Defaut**

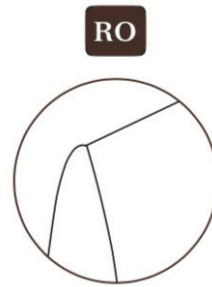

Ronde

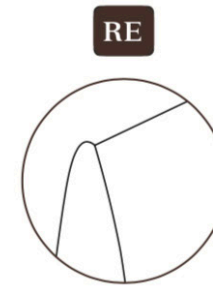

Regular

# Le bas de manche & les boutonsnières

	3 boutons	4 boutons	5 boutons	6 boutons	BOT	BOO
BOUTONNIÈRES FERMÉES	BF3 *	BF4 *	BF5 *	BF6 *	Sans boutonnière sans fente	Sans boutonnière avec fente
BOUTONNIÈRES OUVERTES	BO3 *	BO4	BO5 *	BO6 *		
		L'option par défaut				
	3 boutons chevauchants	4 boutons chevauchants	5 boutons chevauchants	6 boutons chevauchants		BB
BOUTONNIÈRES FERMÉES	BFC3 *	BFC4 *	BFC5 *	BFC6 *		Boutonnieres en biais
BOUTONNIÈRES OUVERTES	BOC3 *	BOC4 *	BOC5 *	BOC6 *		
					SECONDARY OPTIONS	
					<ul style="list-style-type: none"> <li>NC1 - 1ère boutonnière ouverte</li> <li>NC2 - 1&amp;2 boutonnières ouverte</li> <li>NC3 - 1&amp;2&amp;3 boutonnières ouverte</li> <li>NC4 - 1&amp;2&amp;3&amp;4 boutonnières ouverte</li> </ul>	

\* Code a inscrire dans la case "options secondaires".

# Les doublures intérieures

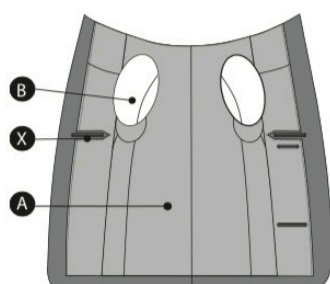

FL

Contrastée

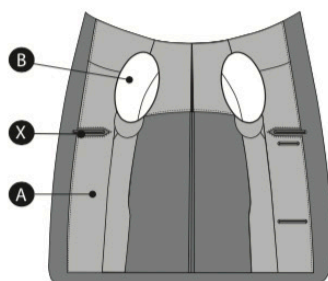

HLB

Demi doublée

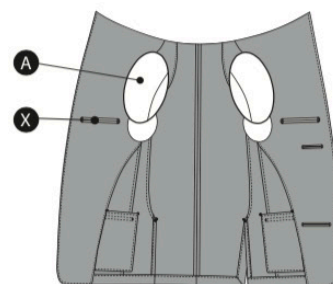

AF

Parmenture américaine non-doublée  
seulement pour vestes déstructurées

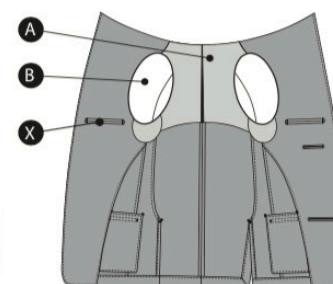

AF1

Parmenture américaine demi doublée  
seulement pour vestes déstructurées

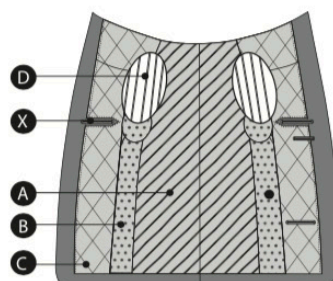

MC

Multico



Sac de poche poitrine  
en doublure "X"

\* Maximum 3 doublures au choix

# La coupe du pantalon

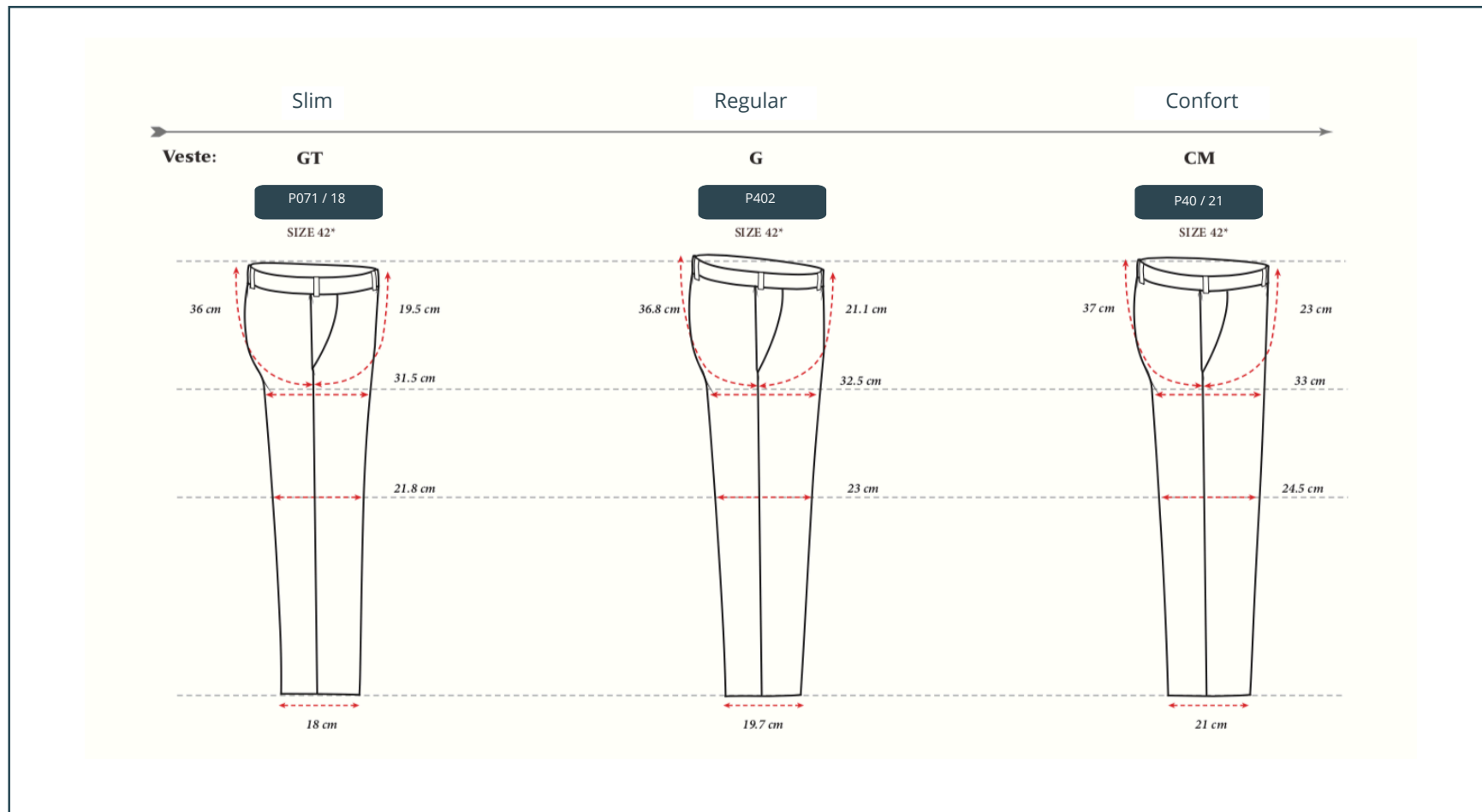

# Le style de poches du pantalon

## Poches avant

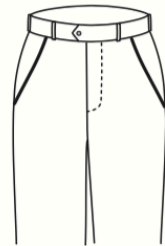

A

Italienne



B

Couture

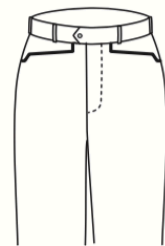

C

Cavalière

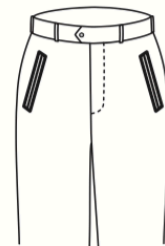

D

Passepoilée

## Poches montre



PMB

Poche montres passepoilées



PMC

Poche montre 1 seul  
passepoilé



PMR

Poche montre  
avec rabat



PM

Poche montre  
sans rabat

## Poches côté

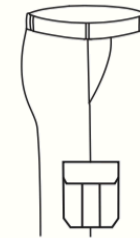

PC

Poches Cargo

# Le style de poche du pantalon

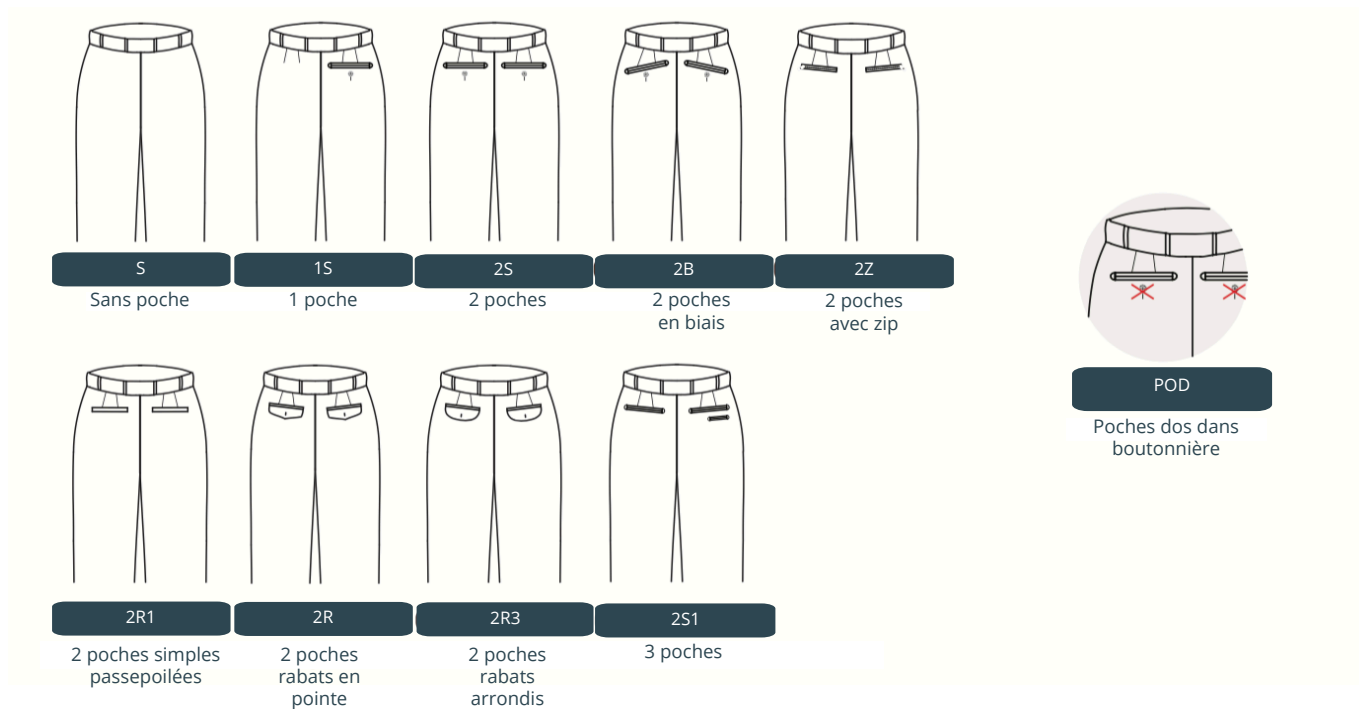



# Le devant de pantalon



P0  
Devant sans pince

\*\*



PSF  
 finition sans pli de  
repassage

\*

Ces options ne sont pas compatibles avec la poche cavalière



P1  
Devant avec 1 pince



P1A  
1 pli vers l'arrière



P1B  
1 pli vers l'avant

\* Disponible en options secondaires

\*\* Default option

# La ceinture



CB

Ceinture sans passant



CN

Ceinture standard

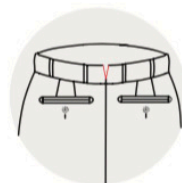

CNV

Ceinture standard et V anatomique 'After Dinner Split'

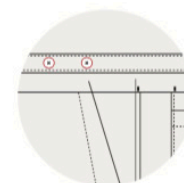

PBR

Boutons bretelles



CD

Ceinture avec passants doubles



CL

Ceinture avec passants larges

# La ceinture



CRE

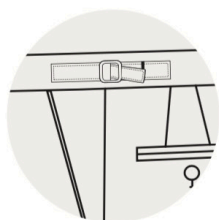

CRM

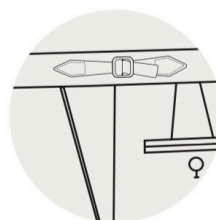

CRMP

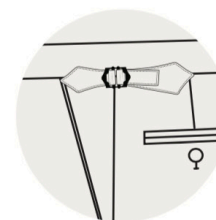

CROP

# Les fermetures du pantalon

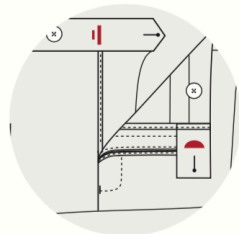

PBA

Fermeture 1 bouton  
1 agrafe

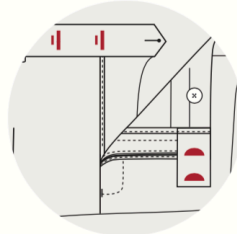

PCA

Fermeture 2 agrafes

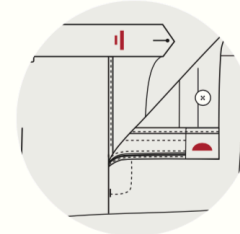

PC1

Fermeture 1 agrafe

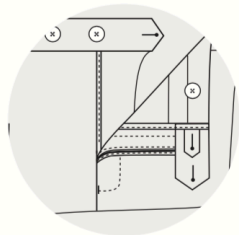

PCB

Fermeture  
2 boutons

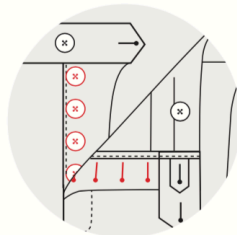

PBB

Fermeture boutons



PBS

Pattes fermeture rallonge

# Le pantalon Sartorial

Le code PA11 sera automatique sélectionné avec l'option 'Traditionnelle' ou 'Semi-traditionnelle'

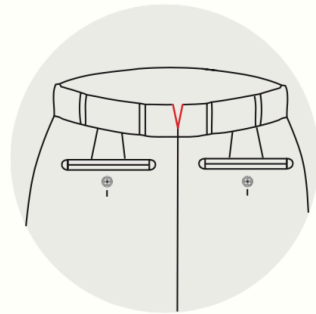

V anatomique  
'After dinner split'

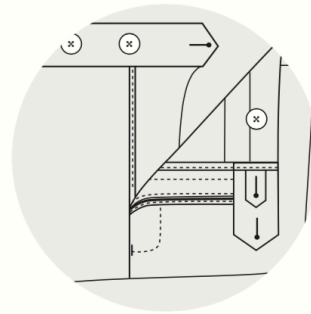

Fermeture double patte  
2 boutons

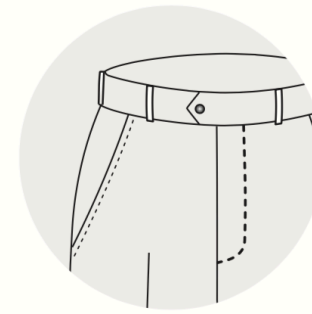

AMF poches et braguette  
pantalon

# La surpiquerie AMF du pantalon

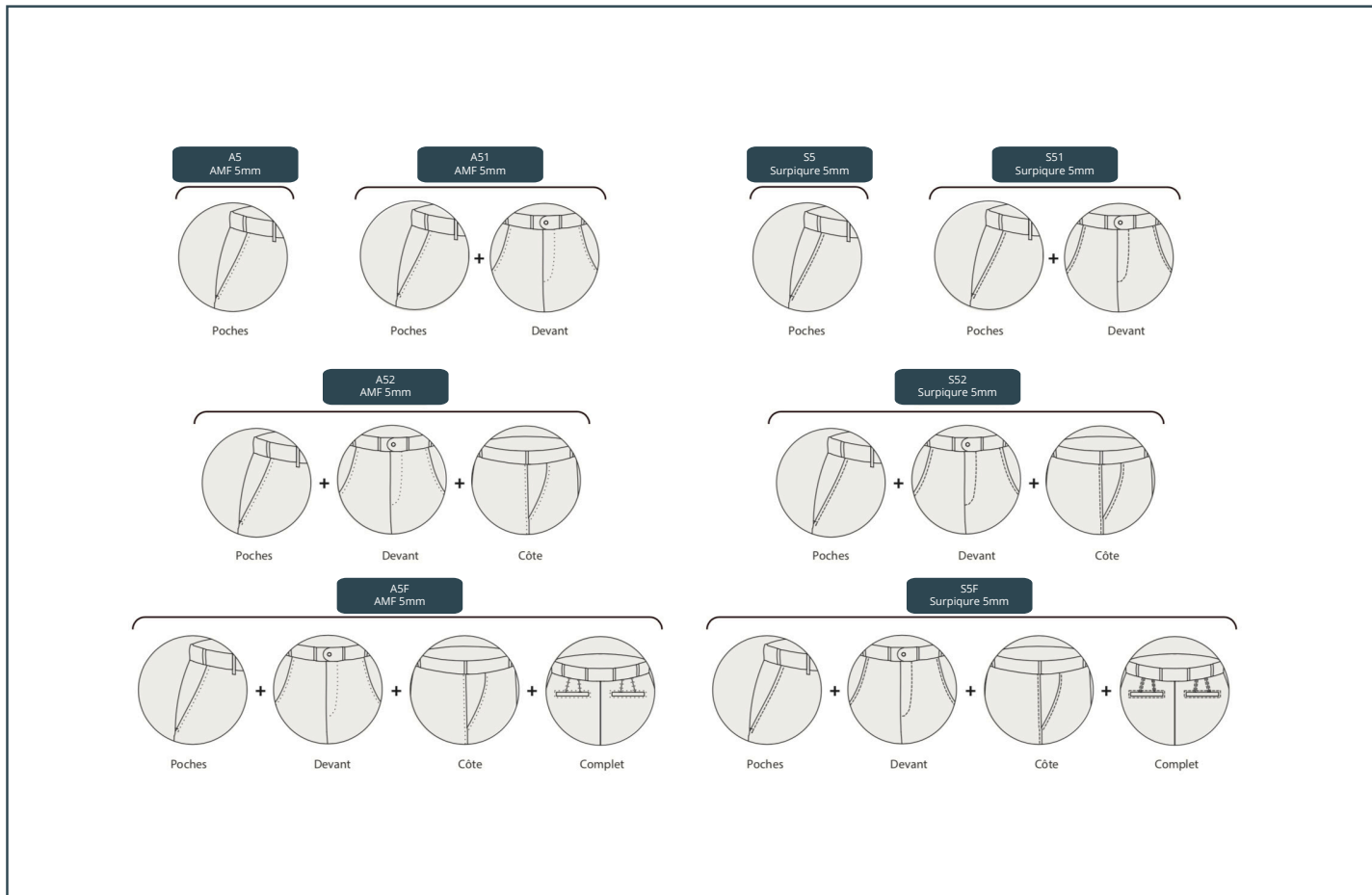

# La finition du bas



# Le gilet de tailleur

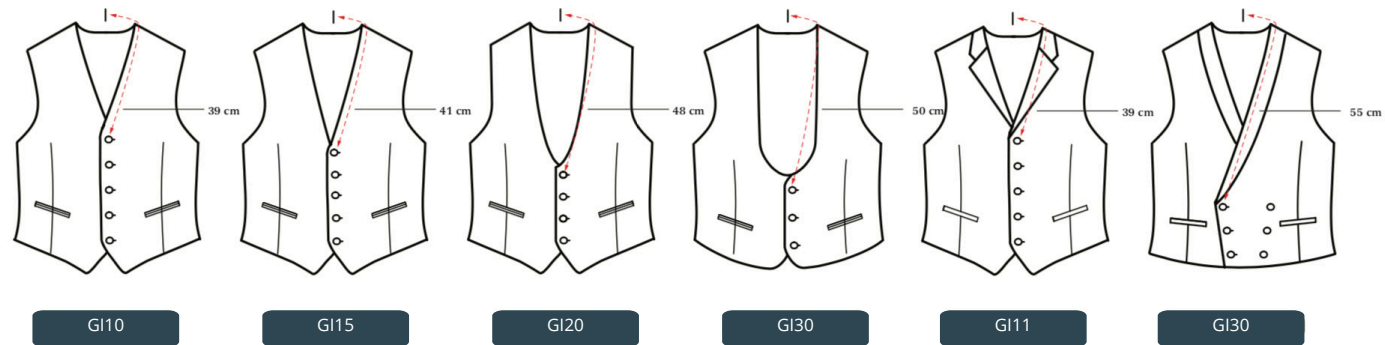

Options de poche

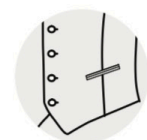

CODE 70



CODE 80



WB10 \*\*

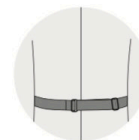

WB20

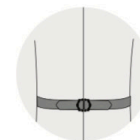

WB30

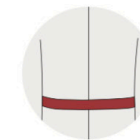

CX

Boucle dos gilet

Contraste dos gilet

! LE NOMBRE DE BOUTONS DÉPENDRA DE LA HAUTEUR D'OUVERTURE ET LONGUEUR DU DOS !

\*\* Default option



# Les options du smoking



RS  
Revers satin noir

RX Revers tissu contraste \*

Disponible pour tous les modèles



RES  
Extérieur revers satin noir

REX Extérieur revers tissu contraste \*

Disponible pour tous les modèles  
G/GT



RIS  
Intérieur revers satin noir

RIX Intérieur revers tissu contraste \*

Disponible pour tous les modèles  
G/GT



BS  
Bande 1 cm satin noir

Bande 1 cm tissu contrasté \*

Disponible pour tous les modèles  
G/GT

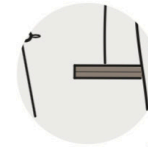

PVS - Passepoils poche veste satin noir \*

PVX - Passepoils poche veste contraste



MFB

Tissu principal



SBB

Satin noir



BS  
bande de 1 cm satin noir

BX  
bande de 1 cm satin noir \*



PPS  
Poches passepoilées dos pantalon satin noir

PPX  
Poches passepoilées dos pantalon contrasté \*



PCC  
Ceinture en satin

PCX  
Ceinture en contraste \*



PPC  
Passepoilé dans la couture côté satin noir



PGS  
Pantalon de smoking avec 1 galon satin noir



CS10, CS30, CS40, GS42, GS29, GS99 \*

GS10 - BLANC, GS30 - CRÈME,  
GS40 - GRIS CLAIR, GS42 - GRIS MOYEN,  
GS29 - MARINE, GS99 - NOIR

# Le costume pour enfant

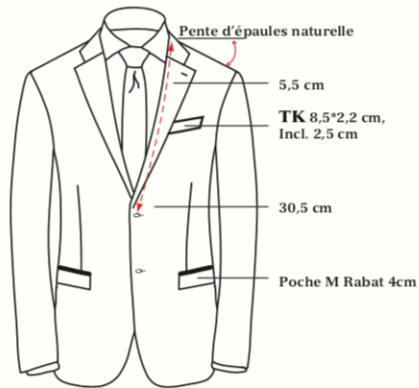

LUCAS

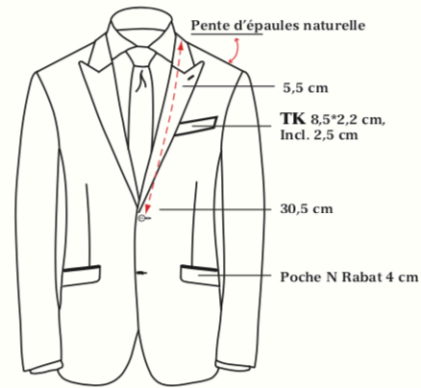

MAX

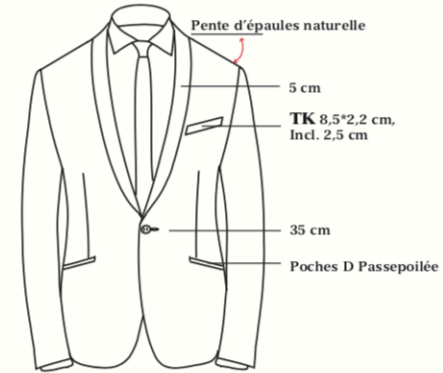

LUCAS 59  
Col châle

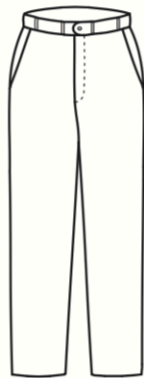

LOUIS

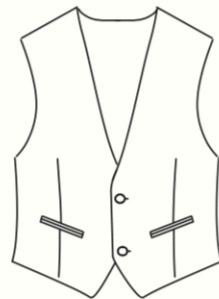

Gilet MAX

Détails de style et options adaptés :



Style :  
3 vraies boutonnières  
droit ouvertes



Style :  
coutures épaules droite

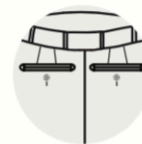

Style :  
2 poche arrière



Option :  
feutre de col  
contrasté



Option :  
coudières en tissu ou en  
Alcantara

# Le costume pour enfant



**C**  
Droites sans rabat



**M**  
Droites à rabat 4 cm avec poche poitrine fine



**D**  
En biais sans rabat



**N**  
En biais à rabats 4cm avec poche poitrine fine



**A11**  
AMF 1 mm, A1  
+ pince devant  
+ fente manche  
+ fente dos  
+ demi-lunes



**A51**  
AMF 5 mm, A5  
+ pince devant  
+ fente manche  
+ fente dos  
+ demi-lunes

+

+



**A1**  
AMF 1mm



**A5**  
AMF 5mm

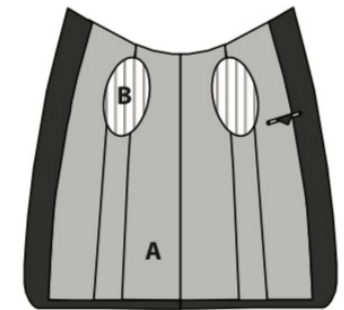

**Sartorial**